

HP 2,7

High power for double-sided Light cabinet

BEST FEATURES

- DESIGNED TO ILLUMINATE **DOUBLE-SIDED LIGHT CABINETS**
- **GENESIS PHOTONICS (TAIWAN)** HIGH POWER LED
- **DOUBLE ANGLE OF RADIATION**
- **EVEN ILLUMINATION STARTING FROM 150 mm CAN DEPTH**
- **CONSTANT CURRENT DRIVING MODE**
- **INSTALLATION BY 1 MODULE**
- **IP65** INGRESS PROTECTION

RECOMMENDED DEPTH FOR LIGHT CABINETS.....150 mm – 250 mm

DIMENSIONS: units in mm

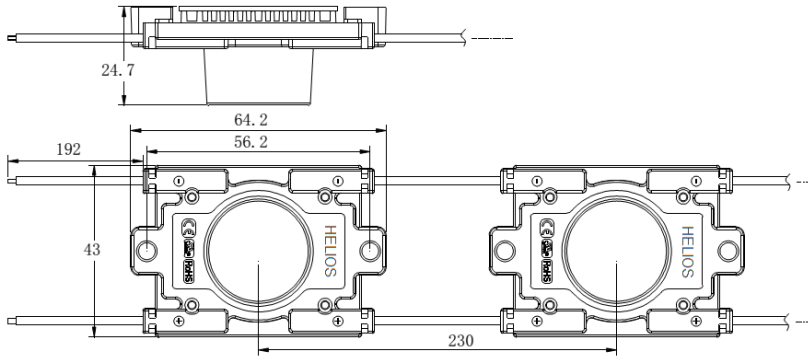

INTENSITY DISTRIBUTION CHART

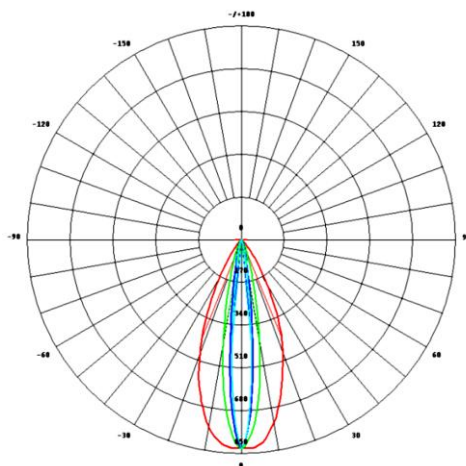

SPECIFICATIONS*:

Part number.....HP 2.7
 Input voltage.....12V DC
 Power consumption (typical).....2.7 Watt
 Drive current.....225 mA
 LED package.....3535
 Housing.....PC + PVC

Lm per module (typical).....254 lm
 Viewing angle12° x 47°
 CRI (minimal).....75

Available colors
 Daylight white.....7,000 K

Max. allowed quantity in series.....15 pcs
 Lead wire.....18 AWG

Ingress protection.....IP 65
 Operating temperature - 25°C to +60°C

Meets the following standards:
 EN 55015:2006+A1+A2
 EN 61547:2009;
 EN60598
 RoHS;
 TUV EN60598-1:2008+A11 (IP TEST)

Packaging
 Tray.....60 pcs
 Master box240 pcs
 Master box G.W.15,4 kg

*Technical data is subject to change without notice

Latvia
 SIA "TAMARS" (office & warehouse)
 Reģ. Nr.: 43603036217
 Adrese: 20 Braslas iela, Offis 115
 Rīga, LV-1084, Latvija
 Tel.: +371 67040635
 E-mail: info@ledunicom.lv
 www.ledunicom.lv

Belarus
 KIMIX LTD. (office & warehouse)
 VAT No. 100006365
 Legal address: 15 Zhilunovich str. off. 310
 Minsk, BY-220026, Belarus
 Tel.: +375 172950901
 E-mail: info@kimix.by
 www.kimix.by

Russia
 ООО «ХЕЛИОС ЛЕД»
 ИНН. 6732077309
 Адрес: 21А Ул. Багратиона.
 Смоленск, RU- 214025, Россия
 Тел.: +79267581371
 E-mail: Yurchenko@helios-led.com
 www.helios-led.com